

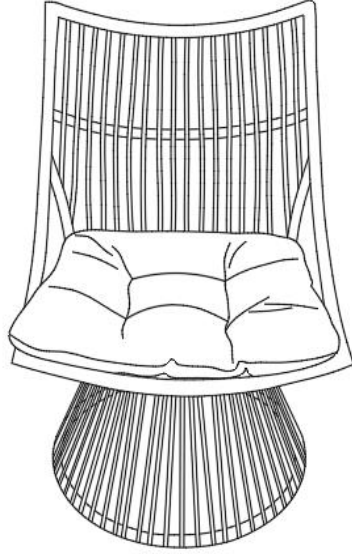

# Assembly Instructions

Caution: You must read this before you proceed.



## Chair

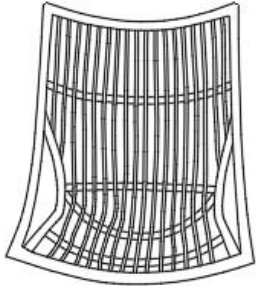

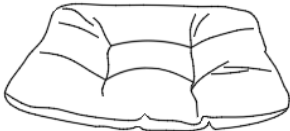
## Parts List

Label	Picture	Description	QTY
A		Seat	1
B		Base	1
C		Cushion	1

# Hardware

Label	Picture	Description	QTY
①		Allen <b>Wrench</b>	1
②		<b>Bolt</b> (M6x30MM)	5
③		Washer	5

## Assembly Preparation

Before Beginning Assembly:

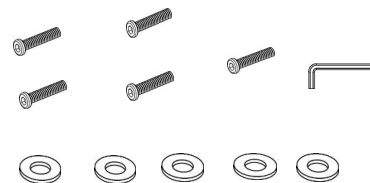
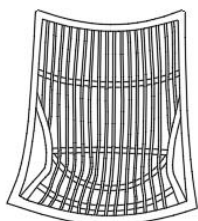

- Read instructions, cover to cover-



- Have 2 adults on hand for assembly-



- Do not assemble on flooring or carpet-



- Assemble on a clean non-marring surface (packing foam)-



- Save all packaging until finished-

## Assembly Steps

### Overview

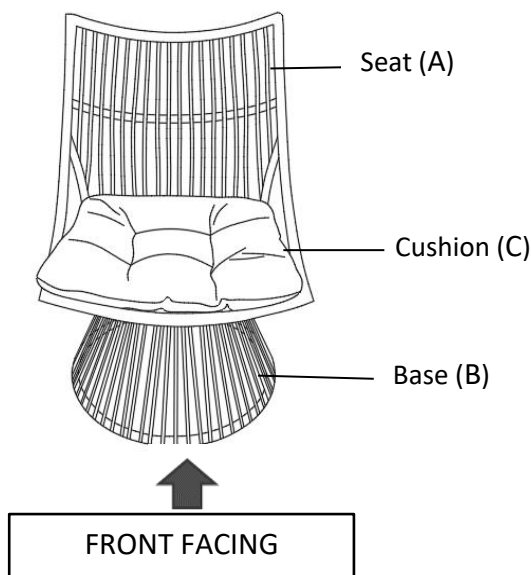

This chair has multiple parts and may require up to some 30 minutes to assemble. To give you an overview of the chair parts, the above picture is to help you put the various parts into perspective. Please read through the instructions below to familiarise yourself with the parts and steps before assembly.

## Step 1

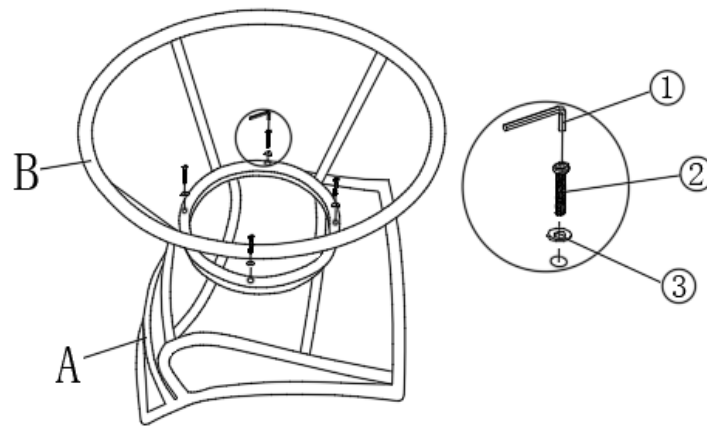

Open the carton and place all the parts onto a clean, non-marring surface.

Place the Seat (A) on the ground, as shown in picture above.

Attach the Base (C) to the Seat (A) using Bolts (2) with Washers (3) with Allen Wrench (1) as shown in the picture above.

Do not fully tighten the bolts.

## Step 2

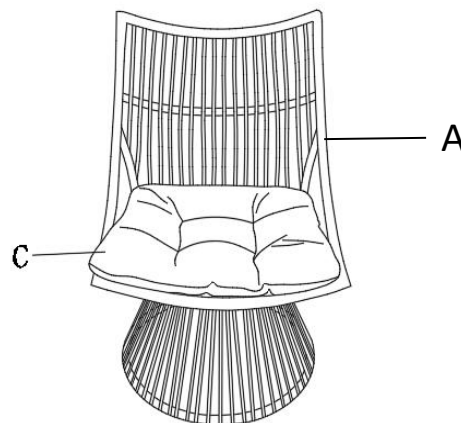

Put the Cushion (C) onto the Seat (A). Then tie the rope on the Cushion (C) to the seat (A).

## Step 3

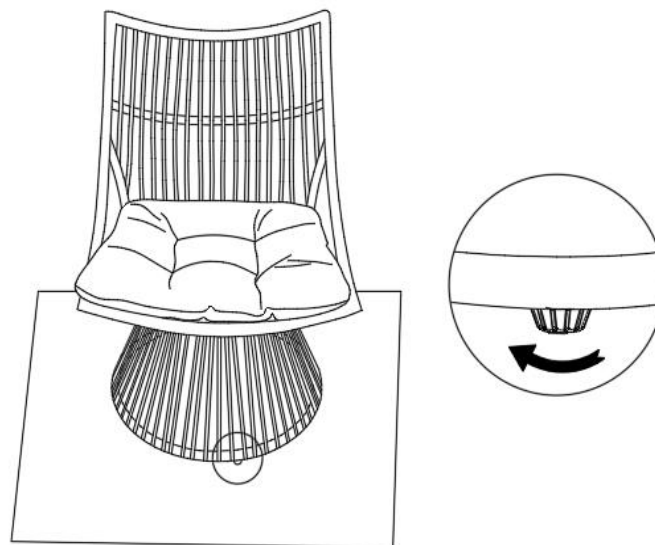











Place the Chair on a LEVEL SURFACE to check for wobbles.

If it wobbles, adjust the Legs Pre-installed Levellers until the Chair is level with the ground.

Your Chair is ready for use.

**This Chair can only be used on a flat, level surface.**

# Care & Maintenance

- ⊘  Prolonged exposure to rain may cause rusting which can stain floors.
  - ⊘  Do not put hot items directly on furniture surface.
  - ⊘  Do not clean furniture with harsh cleansers or polish.
  - ✓  To obtain the longest lifespan of your outdoor products, minimizing exposure to direct sunlight is recommended.
  - ⊘  Children should not climb or jump on the furniture.
  - ⊘  Do not write on furniture without a padded barrier to protect the surface.
  - ✓  To obtain the longest lifespan of your outdoor products, avoid extended and lengthy exposure to rain, snow, and direct sunshine. Whenever possible cover the product and /or place under patio or awnings.
  - ⊘  Not for commercial use. For residential use only.
  - ⊘  Stains may be removed with mild soap solution and damp cloth.
  - ✓  Keep away from sources of ignition.
- 
- ✓  Dust and pick-up spills using a clean, non-colored, lint-free cloth.